

## Serie Tubes

### Tubi e Spirali in Poliamide

Polyamide Tubes and Spirals  
Rohre und Spiralrohre aus Polyamid  
Tubes et Tubes Spirales en Polyamide  
Tubo y Espirales en Poliamida  
Tubos e Espirais de Poliamida



### Tubi e Spirali in Poliuretano Poliester 98 Shore A

Polyurethane Polyester 98 Shore A Tubes and Spirals  
Rohre und Spiralrohre aus Polyurethan-Polyether 98 Shore A  
Tubes et Tubes Spirales en Polyuréthane Polyéther 98 Shore A  
Tubo y Espirales en Poliuretano Poliéster 98 Shore A  
Tubos e Espirais de Poliuretano Poliéster 98 Shore A

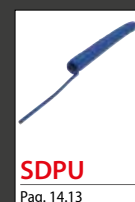

### Tubi in Poliuretano Polietere 90 Shore A

Polyether Polyurethane 90 Shore A Tubes  
Rohre aus Polyurethan-Polyether 90 Shore A  
Tubes en Polyuréthane Polyéther 90 Shore A  
Tubo y Espirales en Poliuretano Poliéter 90 Shore A  
Tubos e Espirais de Poliuretano Poliéster 90 Shore A



### Tubi in FEP - PTFE

FEP - PTFE Tubes  
Rohre aus FEP - PTFE  
Tubes en FEP - PTFE  
Tubo en FEP - PTFE  
Tubos de FEP - PTFE



### Tubo PVC

PVC Tube  
PVC Rohr  
Tuyau PVC  
Tubo PVC  
Tubo de PVC

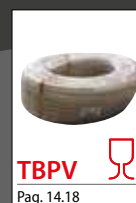

### Tubo in polietilene

Polyethylene tube  
Rohre aus polyethylen  
Tube en polyéthylène  
Tubo en polietilene  
Tubo de polietileno

### Tubi Autobloccanti

Push-Lock Tubes  
Schnellsteckschläuche  
Tuyaux Auto-Serrants  
Tubería Autoblocante  
Tubo Push-Lock



### Accessori

Accessories  
Zubehör  
Accessoires  
Accesorios  
Acessórios

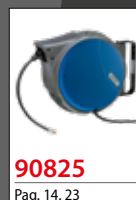
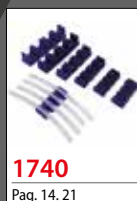

### Kit soffiaggio

Blower Kit  
Gebläse-Kit  
Kit soufflette  
Kit de ventilador  
Kit ventilador

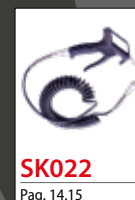
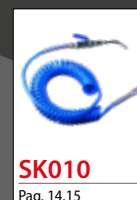

## TUBI IN MATERIALE PLASTICO

PLASTIC TUBES

PLASTIK ROHRE

TUBES ET TUYAUX TECHNIQUES

TUBOS EN MATERIAL PLÁSTICO

TUBOS EM MATERIAL PLÁSTICO



**Serie Tubes**



### CARATTERISTICHE TECNICHE

TECHNICAL CHARACTERISTICS  
TECHNISCHE ANGABEN  
CARACTÉRISTIQUES TECHNIQUES  
CARACTERÍSTICAS TÉCNICAS  
CARACTERÍSTICAS TÉCNICAS



### Norma di Riferimento

Reference standard  
Entspricht der Norm  
Norme de référence  
Normativa de referencia  
Norma de referência

1907/2006  
REACH ✓

2011/65/CE  
RoHS ✓

PEP  
2014/68/UE

SILICON  
FREE

MATERIALI  
MATERIALS  
MATERIALIEN  
MATERIAUX  
MATERIALES  
MATERIAIS

POLIAMIDE  
POLYAMIDE  
POLYAMID  
POLYAMIDE  
POLIAMIDA  
POLIAMIDA

POLIURETANO 98 SHORE A  
POLYURETHANE 98 SHORE A  
POLYURETHAN 98 SHORE A  
POLYURÉTHANE 98 SHORE A  
POLIURETANO 98 SHORE A  
POLIURETANO 98 SHORE A

PTFE

FEP

PVC

NBR/PVC

COLORI STANDARD  
STANDARD COLORS  
STANDARD FARBEN  
COULEURS STANDARDS  
COLORES STANDARD  
CORES PADRÃO

**NT** NEUTRO  
NEUTRAL  
NEUTRAL  
NEUTRE  
NEUTRAL  
NEUTRO

**GI** GIALLO  
YELLOW  
GELB  
JAUNE  
AMARILLO  
AMARELO

**AZ** AZZURRO  
LIGHT BLUE  
HELLBLAU  
BLEU CLAIR  
AZUL  
AZUL CLARO

**GR** GRIGIO  
GREY  
GRAU  
GRIS  
GRIS  
CINZA

**BL** BLU  
BLUE  
BLAU  
BLEU  
AZUL OSCURO  
AZUL

**RO** ROSSO  
RED  
ROT  
ROUGE  
ROJO  
VERMELHO

**NE** NERO  
BLACK  
SCHWARZ  
NOIR  
NEGRO  
PRETO

**VE** VERDE  
GREEN  
GRÜN  
VERT  
VERDE  
VERDE

## TUBO IN POLIAMIDE

POLYAMIDE TUBE  
ROHRE AUS POLYAMID  
TUBE POLYAMIDE  
TUBO EN POLIAMIDA  
TUBO DE POLIAMIDA

## TB12

TUBO IN POLIAMIDE  
POLYAMIDE TUBE  
ROHRE AUS POLYAMID IN SCHACHTELN  
TUBE POLYAMIDE  
TUBO EN POLIAMIDA  
TUBO DE POLIAMIDA

New



= Anti UV

Code	Colore Color Farbe Couleur Color Cor							Est.	Int.	Raggio di curvatura Bending radius Biegeradius Rayon de courbure Radio curvatura Raio de curvatura	Pressione d'esercizio Working pressure Betriebsdruck Pression de travail Presión de ejercicio Pressão de trabalho	Pressione di scoppio Burst pressure Berstdruck Pression d'éclatement Presión de rotura Pressão de ruptura	Tolleranza Tolerance Toleranz Tolérance Tolerancia Tolerância	Pack.
TB12 00 210	-	-	NE	-	-	-	-	2	1	10	44	133	± 0.07	100
TB12 00 315	NT	-	NE	-	-	-	-	3	1.5	10	44	133	± 0.07	100
TB12 00 427	NT	AZ	NE	GI	GR	RO	VE	4	2.7	25	26	78	± 0.07	100
TB12 00 530	NT	AZ	NE	-	-	-	-	5	3	30	33	100	± 0.07	100
TB12 00 640	NT	AZ	NE	GI	GR	RO	VE	6	4	30	27	80	± 0.07	100
TB12 00 860	NT	AZ	NE	GI	GR	RO	VE	8	6	40	19	57	± 0.07	100
TB12 01 075	NT	-	NE	-	-	-	-	10	7.5	60	19	57	± 0.07	100
TB12 01 080	NT	AZ	NE	GI	GR	RO	VE	10	8	60	15	44	± 0.07	100
TB12 12 100	NT	AZ	NE	-	-	-	-	12	10	85	12	36	± 0.10	100
TB12 14 120	NT	AZ	NE	-	-	-	-	14	12	100	10	30	± 0.10	50
TB12 15 125	NT	AZ	NE	-	-	-	-	15	12.5	100	12	36	± 0.10	50
TB12 16 120	NT	-	NE	-	-	-	-	16	12	95	19	57	± 0.10	50

**TUBO IN POLIAMIDE DIMENSIONI IN POLLICI**

POLYAMIDE TUBE INCHES DIMENSIONS

ROHRE AUS POLYAMID (ZOLLMASS)

TUBE POLYAMIDE (DIMENSIONS EN POUCE)

TUBO EN POLIAMIDA DIMENSIONES EN PULGADA

TUBO DE POLIAMIDA DIMENSÕES EM POLEGADAS

Code	Colore Color Farbe Couleur Color Cor	Est. mm	Int. mm	Raggio di curvatura Bending radius Biegeradius Rayon de courbure Radio curvatura Raio de curvatura	Pressione d'esercizio Working pressure Betriebsdruck Pression de travail Presión de ejercicio Pressão de trabalho	Pressione di scoppio Burst pressure Berstdruck Pression d'éclatement Presión de rotura Pressão de ruptura	Tolleranza Tolerance Toleranz Tolérance Tolerancia Tolerância	Pack. Mt
<b>TB12 31 721</b>	<b>NE</b>	1/8 (3.17)	2.18	25	24	74	± 0.07	100
<b>TB12 63 543</b>	<b>NE</b>	1/4 (6.35)	4.35	40	24	74	± 0.07	100
<b>TB12 95 271</b>	<b>NE</b>	3/8 (9.52)	7.14	55	19	57	± 0.07	100
<b>TB12 12 795</b>	<b>NE</b>	1/2 (12.7)	9.52	65	19	57	± 0.10	100

## TS12

**TUBO IN POLIAMIDE - LUNGHEZZA 25 Mt**

POLYAMIDE TUBE - LENGHT 25 Mt

ROHRE AUS POLYAMID - LÄNGE 25 Mt

TUBE POLYAMIDE - ROULEAU DE 25 Mt

TUBO EN POLIAMIDA - LONGITUD 25 Mt

TUBO DE POLIAMIDA - LONGITUDE 25 Mt



= Anti UV

Code	Colore Color Farbe Couleur Color Cor	Est. mm	Int. mm	Raggio di curvatura Bending radius Biegeradius Rayon de courbure Radio curvatura Raio de curvatura	Pressione d'esercizio Working pressure Betriebsdruck Pression de travail Presión de ejercicio Pressão de trabalho	Pressione di scoppio Burst pressure Berstdruck Pression d'éclatement Presión de rotura Pressão de ruptura	Tolleranza Tolerance Toleranz Tolérance Tolerancia Tolerância	Pack.
<b>TS12 00 427</b>	<b>NT AZ NE GI GR RO VE</b>	4	2.7	25	26	78	± 0.07	1
<b>TS12 00 530</b>	<b>NT AZ NE - - - -</b>	5	3	30	33	100	± 0.07	1
<b>TS12 00 640</b>	<b>NT AZ NE GI GR RO VE</b>	6	4	30	27	80	± 0.07	1
<b>TS12 00 860</b>	<b>NT AZ NE GI GR RO VE</b>	8	6	40	19	57	± 0.07	1
<b>TS12 01 080</b>	<b>NT AZ NE - - - -</b>	10	8	60	15	44	± 0.07	1
<b>TS12 12 100</b>	<b>NT AZ NE - - - -</b>	12	10	85	12	36	± 0.10	1
<b>TS12 14 120</b>	<b>NT AZ NE - - - -</b>	14	12	100	10	30	± 0.10	1

**TUBO IN POLIAMIDE DIMENSIONI IN POLLICI - LUNGHEZZA 25 Mt**

POLYAMIDE TUBE INCHES DIMENSIONS - LENGHT 25 Mt

ROHRE AUS POLYAMID (ZOLLMASS) - LÄNGE 25 Mt

TUBE POLYAMIDE (DIMENSIONS EN POUCE) - ROULEAU DE 25 Mt

TUBO EN POLIAMIDA DIMENSIONES EN PULGADA - LONGITUD 25 Mt

TUBO DE POLIAMIDA DIMENSÕES EM POLEGADAS - LONGITUDE 25 Mt

Code	Colore Color Farbe Couleur Color Cor	Est. Inch	Int. Inch	Raggio di curvatura Bending radius Biegeradius Rayon de courbure Radio curvatura Raio de curvatura	Pressione d'esercizio Working pressure Betriebsdruck Pression de travail Presión de ejercicio Pressão de trabalho	Pressione di scoppio Burst pressure Berstdruck Pression d'éclatement Presión de rotura Pressão de ruptura	Tolleranza Tolerance Toleranz Tolérance Tolerancia Tolerância	Pack.
<b>TS12 31 721</b>	<b>NE</b>	1/8 (3.17)	2.18	25	24	74	± 0.07	1
<b>TS12 63 543</b>	<b>NE</b>	1/4 (6.35)	4.35	40	24	74	± 0.07	1
<b>TS12 95 271</b>	<b>NE</b>	3/8 (9.52)	7.14	55	19	57	± 0.07	1
<b>TS12 12 795</b>	<b>NE</b>	1/2 (12.7)	9.52	65	19	57	± 0.10	1

**Temperatura d'uso**

Temperature Range

Temperaturbereich

Température d'utilisation

Temperatura de Ejercicio

Temperatura de Trabalho

- 40 °C

+ 100 °C



Tabella delle pressioni espresse in % in funzione della temperatura  
 Table of pressure values expressed in% as a function of temperature  
 Tabelle In Abhängigkeit Der Temperaturen Die Druckwerte In % Angegeben  
 Valeurs de pression (en %) en fonction de la température  
 Tabla de las presiones expresadas en % en función de la temperatura  
 Tabela das pressões expressas em % em função da temperatura

20°	40°	60°	80°	100°
100%	85%	60%	40%	20%

## TB12A

### TUBO IN POLIAMIDE AUTOESTINGUENTE

PA SELF-EXTINGUISHING TUBE  
 POLYAMID-ROHR FEUERRESISTENT  
 TUBE POLYAMIDE AUTO EXTINGUIBLE  
 TUBO EN POLIAMIDA AUTOEXTINGUENTE  
 TUBO EM POLIURETANO ANTI-PROPAGAÇÃO DE CHAMAS



**UL 94 V2**

Code	Colore Color Farbe Couleur Color Cor	Est.	Int.	Raggio di curvatura Bending radius Biegeradius Rayon de courbure Radio curvatura Raio de curvatura	Pressione d'esercizio	Pressione di scoppio	Pack.
					Working pressure Betriebsdruck Pression de travail Presión de ejercicio Pressão de trabalho	Burst pressure Burst pressure Berstdruck Pression d'éclatement Presión de rotura Pressão de ruptura	
					a/at 20°C	a/at 20°C	
					bar	bar	Mt
TB12A 00 427	AZ	4	2.7	25	28	85	100
TB12A 00 640	AZ	6	4	35	29	88	100
TB12A 00 860	AZ	8	6	40	21	63	100
TB12A 01 080	AZ	10	8	60	16	49	100
TB12A 12 100	AZ	12	10	85	13	40	100
TB12A 15 125	AZ	15	12.5	100	13	40	50



#### Temperatura d'uso

Temperature Range

Temperaturbereich



Température d'utilisation

Temperatura de Ejercicio

Temperatura de Trabalho

- 30 °C  
+ 70 °C

Tabella delle pressioni espresse in % in funzione della temperatura  
 Table of pressure values expressed in% as a function of temperature  
 Tabelle In Abhängigkeit Der Temperaturen Die Druckwerte In % Angegeben  
 Valeurs de pression (en %) en fonction de la température  
 Tabla de las presiones expresadas en % en función de la temperatura  
 Tabela das pressões expressas em % em função da temperatura

20°	30°	40°	50°	60°
100%	72%	64%	52%	47%

## TB12X

### TUBO IN POLIAMIDE MULTISTRATO ANTISTATICO

PA MULTILAYER ANTISTATIC TUBE  
 POLYAMID-ROHR ANTISTATISCH  
 TUBE POLYAMIDE ANTISTATIQUE  
 TUBO EN POLIAMIDA MULTICAPA ANTIESTÁTICO  
 TUBO EM POLIAMIDA MULTI-CAMADAS ANTI-ESTÁTICO



**Ex** ATEX II 2 G/D

Code	Colore Color Farbe Couleur Color Cor	Est.	Int.	Raggio di curvatura Bending radius Biegeradius Rayon de courbure Radio curvatura Raio de curvatura	Pressione d'esercizio	Pressione di scoppio	Tolleranza	Pack.
					Working pressure Betriebsdruck Pression de travail Presión de ejercicio Pressão de trabalho	Burst pressure Burst pressure Berstdruck Pression d'éclatement Presión de rotura Pressão de ruptura	Tolerance Toleranz Tolérance Tolerancia Tolerância	
					a/at 20°C	a/at 20°C		
					bar	bar	mm	Mt
TB12X 00 425	NE	4	2.5	30	25	74	± 0.10	100
TB12X 00 640	NE	6	4	45	15	45	± 0.10	100
TB12X 00 860	NE	8	6	55	10	29	± 0.10	100
TB12X 01 080	NE	10	8	70	7	21	± 0.10	100
TB12X 12 100	NE	12	10	100	5	16	± 0.10	100



#### Temperatura d'uso

Temperature Range

Temperaturbereich



Température d'utilisation

Temperatura de Ejercicio

Temperatura de Trabalho

- 30 °C  
+ 80 °C

Tabella delle pressioni espresse in % in funzione della temperatura  
 Table of pressure values expressed in% as a function of temperature  
 Tabelle In Abhängigkeit Der Temperaturen Die Druckwerte In % Angegeben  
 Valeurs de pression (en %) en fonction de la température  
 Tabla de las presiones expresadas en % en función de la temperatura  
 Tabela das pressões expressas em % em função da temperatura

20°	40°	60°	80°
100%	85%	60%	40%

## TB12P

### TUBO IN POLIAMIDE RIVESTITO IN PU ANTISCINTILLA IGNIFUGO

PA TUBE WITH PU LAYER – FIREPROOF ANTI-SPARK

POLYAMID-ROHR SCHWEISSSPRITZABWEISEND

TUBE POLYAMIDE AVEC GAINÉ EN PU IGNIFUGE ANTI ETINCELLE

TUBO EN POLIAMIDA REVESTIDO EN PU ANTICHISPA IGNÍFUGO

TUBO EM POLIAMIDA REVESTIDO EM PU ANTI-CHAMA

**UL 94 V0**

Code	Colore Color Farbe Couleur Color Cor	Est.	Int.	Est. Cover	Raggio di curvatura Bending radius Biegeradius Rayon de courbure Radio curvatura Raio de curvatura	Pressione d'esercizio	Pressione di scoppio	Pack.
						Working pressure Betriebsdruck Pression de travail Presión de ejercicio Pressão de trabalho	Burst pressure Berstdruck Pression d'éclatement Presión de rotura Pressão de ruptura	
						a/at 20°C	a/at 20°C	
						bar	bar	Mt
TB12P 00 420	NE	4	2	6	10	56	167	100
TB12P 00 640	NE	6	4	8	20	33	100	100
TB12P 00 860	NE	8	6	10	30	24	71	100
TB12P 01 075	NE	10	7.5	12	40	24	71	100
TB12P 01 290	NE	12	9	14	70	24	71	100



#### Temperatura d'uso

Temperature Range

Temperaturbereich



Température d'utilisation

Temperatura de Ejercicio

Temperatura de Trabalho

- 40 °C

+ 80 °C

Tabella delle pressioni espresse in % in funzione della temperatura  
Table of pressure values expressed in% as a function of temperature  
Tabelle In Abhängigkeit Der Temperaturen Die Druckwerte In % Angegeben  
Valeurs de pression (en %) en fonction de la température  
Tabla de las presiones expresadas en % en función de la temperatura  
Tabela das pressões expressas em % em função da temperatura

20°	40°	60°	80°
100%	85%	60%	40%

## TB66

### TUBO IN POLIAMIDE RIGIDO

POLYAMIDE SEMIRIGID TUBE

ROHRE AUS POLYAMID, HALBSTARR

TUBE POLYAMIDE RIGIDE

TUBO EN POLIAMIDA RÍGIDO

TUBO RÍGIDO EM POLIAMIDA

**serie 58000**

Code	Colore Color Farbe Couleur Color Cor	Est.	Int.	Raggio di curvatura Bending radius Biegeradius Rayon de courbure Radio curvatura Raio de curvatura	Pressione d'esercizio	Pressione di scoppio	Pack.	
					Working pressure Betriebsdruck Pression de travail Presión de ejercicio Pressão de trabalho	Burst pressure Berstdruck Pression d'éclatement Presión de rotura Pressão de ruptura		
						a/at 20°C	a/at 20°C	
						bar	bar	Mt
TB66 00 420	NT	4	2	25	100	300	100	
TB66 00 630	NT	6	3	45	100	300	100	



#### Temperatura d'uso

Temperature Range

Temperaturbereich



Température d'utilisation

Temperatura de Ejercicio

Temperatura de Trabalho

0 °C

+ 100 °C

Tabella delle pressioni espresse in % in funzione della temperatura  
Table of pressure values expressed in% as a function of temperature  
Tabelle In Abhängigkeit Der Temperaturen Die Druckwerte In % Angegeben  
Valeurs de pression (en %) en fonction de la température  
Tabla de las presiones expresadas en % en función de la temperatura  
Tabela das pressões expressas em % em função da temperatura

20°	30°	40°	50°	60°	70°	80°
100%	83%	72%	64%	58%	52%	47%

## TUBO IN POLIURETANO POLIESTERE 98 SHORE A

98 SHORE A POLYURETHANE POLYESTER TUBE  
 ROHRE AUS POLYURETHAN-POLYESTER 98 SHORE A  
 TUBE EN POLYURÉTHANE POLYESTER 98 SHORE A  
 TUBO EN POLIURETANO POLIÉSTER 98 SHORE A  
 TUBO DE POLIURETANO POLIÉSTER 98 SHORE A

### TBPU

#### TUBO IN POLIURETANO POLIESTERE 98 SHORE A

98 SHORE A POLYURETHANE POLYESTER TUBE  
 ROHRE AUS POLYURETHAN-POLYESTER 98 SHORE A  
 TUBE EN POLYURÉTHANE POLYESTER 98 SHORE A  
 TUBO EN POLIURETANO POLIÉSTER 98 SHORE A  
 TUBO DE POLIURETANO POLIÉSTER 98 SHORE A



New

Code	Colore Color Farbe Couleur Color Cor					Est. mm	Int. mm	Raggio di curvatura Bending radius Biegeradius Rayon de courbure Radio curvatura Raio de curvatura	Pressione d'esercizio Working pressure Betriebsdruck Pression de travail Presión de ejercicio Pressão de trabalho	Pressione di scoppio Burst pressure Berstdruck Pression d'éclatement Presión de rotura Pressão de ruptura	Tolleranza Tolerance Toleranz Tolérance Tolerancia Tolerância	Pack. Mt
	White	Blue	Black	Yellow	Red							
TBPU 00 425	NT	AZ	NE	-	RO	4	2.5	15	10	40	± 0.10	100
TBPU 00 530	NT	AZ	NE	-	-	5	3	16	12	50	± 0.10	100
TBPU 00 640	NT	AZ	NE	GI	RO	6	4	18	10	40	± 0.10	100
TBPU 00 855	NT	AZ	NE	-	RO	8	5.5	30	10	40	± 0.10	100
TBPU 00 860	NT	AZ	NE	-	RO	8	6	35	7	28	± 0.10	100
TBPU 01 080	NT	AZ	NE	-	RO	10	8	45	5.5	22	± 0.15	100
*TBPU 01 290	NT	AZ	NE	-	RO	12	9	50	6	25	± 0.15	100
TBPU 16 110	NT	AZ	NE	-	-	16	11	75	12	36	± 0.10	50

\* PU-Alloy™ Soft - (95 Shore A)

### TSPU

#### TUBO IN POLIURETANO POLIESTERE 98 SHORE - LUNGHEZZA 25 Mt

98 SHORE A POLYURETHANE POLYESTER TUBE - LENGHT 25 Mt  
 ROHRE AUS POLYURETHAN-POLYESTER 98 SHORE A - LÄNGE 25 Mt  
 TUBE EN POLYURÉTHANE POLYESTER 98 SHORE A - ROULEAU DE 25 Mt  
 TUBO EN POLIURETANO POLIÉSTER 98 SHORE A - LONGITUD 25 Mt  
 TUBO DE POLIURETANO POLIÉSTER 98 SHORE A - COMPRIMENTO DE 25 Mt



Code	Colore Color Farbe Couleur Color Cor			Est. mm	Int. mm	Raggio di curvatura Bending radius Biegeradius Rayon de courbure Radio curvatura Raio de curvatura	Pressione d'esercizio Working pressure Betriebsdruck Pression de travail Presión de ejercicio Pressão de trabalho	Pressione di scoppio Burst pressure Berstdruck Pression d'éclatement Presión de rotura Pressão de ruptura	Tolleranza Tolerance Toleranz Tolérance Tolerancia Tolerância	Pack. 1
	White	Blue	Black							
TSPU 00 425	NT	AZ	NE	4	2.5	15	10	40	± 0.10	1
TSPU 00 640	NT	AZ	NE	6	4	18	10	40	± 0.10	1
TSPU 00 855	NT	AZ	NE	8	5.5	30	10	40	± 0.10	1
TSPU 00 860	NT	AZ	NE	8	6	35	7	28	± 0.10	1
TSPU 01 080	NT	AZ	NE	10	8	45	5.5	22	± 0.15	1
TSPU 01 290	NT	AZ	NE	12	9	50	6	25	± 0.15	1



Temperatura d'uso

Temperature Range

Temperaturbereich



Température d'utilisation

Temperatura de Ejercicio

Temperatura de Trabalho

- 40 °C  
+ 60 °C

Tabella delle pressioni espresse in % in funzione della temperatura  
 Table of pressure values expressed in% as a function of temperature  
 Tabelle In Abhängigkeit Der Temperaturen Die Druckwerte In % Angegeben.  
 Valeurs de pression (en %) en fonction de la température  
 Tabla de las presiones expresadas en % en función de la temperatura  
 Tabela das pressões expressas em % em função da temperatura

-20°	0°	20°	30°	40°	50°	60°
185%	140%	100%	85%	70%	60%	50%

## TUBO IN POLIURETANO POLIETERE 90 SHORE A

90 SHORE A POLYURETHANE POLYETHER TUBE  
 ROHRE AUS POLYURETHAN-POLYETHER 90 SHORE A  
 TUBE EN POLYURÉTHANE POLYÉTHÉR 90 SHORE A  
 TUBO EN POLIURETANO POLIÉTER 90 SHORE A  
 TUBO DE POLIURETANO POLIÉTER 90 SHORE A

### TBPO

#### TUBO IN POLIURETANO POLIETERE 90 SHORE A

90 SHORE A POLYURETHANE POLYETHER TUBE  
 ROHRE AUS POLYURETHAN-POLYETHER 90 SHORE A  
 TUBE EN POLYURÉTHANE POLYÉTHÉR 90 SHORE A  
 TUBO EN POLIURETANO POLIÉTER 90 SHORE A  
 TUBO DE POLIURETANO POLIÉTER 90 SHORE A



Code	Colore Color Farbe Couleur Color Cor							Est. mm	Int. mm	Raggio di curvatura Bending radius Biegeradius Rayon de courbure Radio curvatura Raio de curvatura mm	Pressione d'esercizio Working pressure Betriebsdruck Pression de travail Presión de ejercicio Pressão de trabalho a/at 20°C bar	Pressione di scoppio Burst pressure Berstdruck Pression d'éclatement Presión de rotura Pressão de ruptura a/at 20°C bar	Tolleranza Tolerance Toleranz Tolérance Tolerancia mm	Pack. Mt
	White	Blue	Black	Yellow	Grey	Red	Green							
TBPO 00 425	NT	AZ	NE	GI	GR	RO	VE	4	2.5	20	12	37	± 0.07	100
TBPO 00 640	NT	AZ	NE	GI	GR	RO	VE	6	4	30	11	32	± 0.07	100
TBPO 00 855	NT	AZ	NE	GI	GR	RO	VE	8	5.5	45	10	30	± 0.07	100
TBPO 01 070	NT	AZ	NE	-	GR	RO	-	10	7	35	9	28	± 0.07	100
TBPO 01 280	NT	AZ	NE	-	GR	RO	-	12	8	30	11	32	± 0.07	100
TBPO 14 100	NT	AZ	NE	GI	-	RO	-	14	10	120	9	27	± 0.10	100

### TSPO

#### TUBO IN POLIURETANO POLIETERE 90 SHORE A - LUNGHEZZA 25 Mt

90 SHORE A POLYURETHANE POLYETHER TUBE - LENGHT 25 Mt  
 ROHRE AUS POLYURETHAN-POLYETHER 90 SHORE A - LÄNGE 25 Mt  
 TUBE EN POLYURÉTHANE POLYÉTHÉR 90 SHORE A - ROULEAU DE 25 Mt  
 TUBO EN POLIURETANO POLIÉTER 90 SHORE A - LONGITUD 25 Mt  
 TUBO DE POLIURETANO POLIÉTER 90 SHORE A - COMPRIMENTO DE 25 Mt



Code	Colore Color Farbe Couleur Color Cor							Est. mm	Int. mm	Raggio di curvatura Bending radius Biegeradius Rayon de courbure Radio curvatura Raio de curvatura mm	Pressione d'esercizio Working pressure Betriebsdruck Pression de travail Presión de ejercicio Pressão de trabalho a/at 20°C bar	Pressione di scoppio Burst pressure Berstdruck Pression d'éclatement Presión de rotura Pressão de ruptura a/at 20°C bar	Tolleranza Tolerance Toleranz Tolérance Tolerancia mm	Pack.
	White	Blue	Black	Yellow	Grey	Red	Green							
TSPO 00 425	NT	AZ	NE	GI	GR	RO	VE	4	2.5	20	12	37	± 0.07	1
TSPO 00 640	NT	AZ	NE	GI	GR	RO	VE	6	4	30	11	32	± 0.07	1
TSPO 00 855	NT	AZ	NE	GI	GR	RO	VE	8	5.5	45	10	30	± 0.07	1
TSPO 01 070	NT	AZ	NE	-	GR	RO	-	10	7	35	9	28	± 0.07	1
TSPO 01 280	NT	AZ	NE	-	GR	RO	-	12	8	30	11	32	± 0.07	1
TSPO 14 100	NT	AZ	NE	GI	-	RO	-	14	10	120	9	27	± 0.07	1

**Temperatura d'uso**

Temperature Range

Temperaturbereich

Température d'utilisation

Temperatura de Ejercicio

Temperatura de Trabalho

- 40 °C

+ 60 °C



Tabella delle pressioni espresse in % in funzione della temperatura  
 Table of pressure values expressed in % as a function of temperature  
 Tabelle in Abhängigkeit Der Temperaturen Die Druckwerte In % Angegeben  
 Valeurs de pression (en %) en fonction de la température  
 Tabla de las presiones expresadas en % en función de la temperatura  
 Tabela das pressões expressas em % em função da temperatura

20°	30°	40°
100%	60%	40%



**TUBO IN FEP - PTFE**

FEP - PTFE TUBE  
 ROHRE AUS FEP - PTFE  
 TUBE EN FEP - PTFE  
 TUBO EN FEP - PTFE  
 TUBO DE FEP - PTFE

**TBFE**

**TUBO FEP**  
 FEP TUBE  
 ROHRE AUS FEP  
 TUBE EN FEP  
 TUBO EN FEP  
 TUBO DE FEP

**New**

**Anti UV**

Code	Colore Color Farbe Couleur Color Cor	Est. mm	Int. mm	Raggio di curvatura Bending radius Biegeradius Rayon de courbure Radio curvatura Raio de curvatura	Pressione d'esercizio	Pressione di scoppio	Tolleranza Tolerance Toleranz Tolérance Tolerancia Tolerância	Pack. Mt
					a/at 20°C bar	a/at 20°C bar		
<b>TBFE 00 425</b>	<b>NT</b>	4	2.5	21	22	110	± 0.07	50
<b>TBFE 00 640</b>	<b>NT</b>	6	4	36	19	96	± 0.07	50
<b>TBFE 00 860</b>	<b>NT</b>	8	6	64	14	70	± 0.07	50
<b>TBFE 01 080</b>	<b>NT</b>	10	8	100	11	55	± 0.07	50
<b>TBFE 12 100</b>	<b>NT</b>	12	10	144	9	45	± 0.07	50
<b>TBFE 16 140</b>	<b>NT</b>	16	14	256	6	20	± 0.15	50

**TSFE**

**TUBO FEP - LUNGHEZZA 25 Mt**  
 FEP TUBE - LENGHT 25 Mt  
 ROHRE AUS FEP - LÄNGE 25 Mt  
 TUBE EN FEP - ROULEAU DE 25 Mt  
 TUBO FEP - LONGITUD 25 Mt  
 TUBO FEP - COMPRIMENTO DE 25 Mt

**Anti UV**

Code	Colore Color Farbe Couleur Color Cor	Est. mm	Int. mm	Raggio di curvatura Bending radius Biegeradius Rayon de courbure Radio curvatura Raio de curvatura	Pressione d'esercizio	Pressione di scoppio	Tolleranza Tolerance Toleranz Tolérance Tolerancia Tolerância	Pack.
					a/at 20°C bar	a/at 20°C bar		
<b>TSFE 00 425</b>	<b>NT</b>	4	2.5	21	22	110	± 0.07	1
<b>TSFE 00 640</b>	<b>NT</b>	6	4	36	19	96	± 0.07	1
<b>TSFE 00 860</b>	<b>NT</b>	8	6	64	14	70	± 0.07	1
<b>TSFE 01 080</b>	<b>NT</b>	10	8	100	11	55	± 0.07	1
<b>TSFE 12 100</b>	<b>NT</b>	12	10	144	9	45	± 0.07	1

**Temperatura d'uso**

Temperature Range

Temperaturbereich

Température d'utilisation

Temperatura de Ejercicio

Temperatura de Trabalho

- 60 °C

+ 205 °C

Tabella delle pressioni espresse in % in funzione della temperatura  
 Table of pressure values expressed in% as a function of temperature  
 Tabelle in Abhängigkeit Der Temperaturen Die Druckwerte In % Angegeben  
 Valeurs de pression (en %) en fonction de la température  
 Tabla de las presiones expresadas en % en función de la temperatura  
 Tabela das pressões expressas em % em função da temperatura

20°	50°	100°	150°
100%	80%	45%	20%

# TBPF

## TUBO FLESSIBILE IN PTFE

PTFE FLEXIBLE TUBE  
 FLEXIBLES ROHR AUS PTFE  
 TUBE FLEXIBLE EN PTFE  
 TUBO FLEXIBLE EN PTFE  
 TUBO FLEXÍVEL DE PTFE



New



COMPONENT

Anti UV

Code	Colore Color Farbe Couleur Color Cor	Est. mm	Int. mm	Raggio di curvatura Bending radius Biegeradius Rayon de courbure Radio curvatura Raio de curvatura	Pressione d'esercizio Working pressure Betriebsdruck Pression de travail Presión de ejercicio Pressão de trabalho	Pressione di scoppio Burst pressure Berstdruck Pression d'éclatement Presión de rotura Pressão de ruptura	Tolleranza Tolerance Toleranz Tolérance Tolerancia Tolerância	Pack. Mt
TBPF 00 420	NT	4	2	16	35	110	± 0.10	50
TBPF 00 427	NT	4	2.7	25	21	65	± 0.10	50
TBPF 00 530	NT	5	3	25	28	85	± 0.10	50
TBPF 00 640	NT	6	4	36	23	70	± 0.10	50
TBPF 00 860	NT	8	6	64	15	50	± 0.15	50
TBPF 01 080	NT	10	8	100	13	40	± 0.20	50
TBPF 01 210	NT	12	10	144	10	30	± 0.20	50
TBPF 01 614	NT	16	14	256	6	20	± 0.15	50

### Applicazioni Industriali

IT

- Trasporto Fluidi
- Alimentare Food & Beverage
- Elettrodomestici
- Elettronico
- Automobilistico e motociclistico
- Impianti medicali e di laboratorio
- Semiconduttori

### Industrial Applications

GB

- Transport Fluids
- Food Food & Beverage
- Appliances
- Electronic
- Automotive and motorcycle
- Medical equipment and laboratory
- Semiconductors

### Industrielle Anwendungen

DE

- Transport von Flüssigkeiten
- Essen & Trinken
- Haushaltgeräte
- Elektronik
- Automobile & Motorräder
- Medizin - & Labortechnik
- Halbleitertechnik

### Applications industrielles

FR

- Transport de fluides
- Aliments & Boissons
- Electroménager
- Electronique
- Automobile et moto
- Equipement médical et de laboratoire
- Semi-conducteur

### Aplicaciones industriales

ES

- Transporte de Fluidos
- Alimentaria Alimentos & Bebidas
- Electrodomésticos
- Electrónico
- Automovilístico y motociclistico
- Equipos médicos y laboratorios
- Semiconductores

### Aplicações industriais

PT

- Transporte de Fluidos
- Indústria Alimentícias e de Bebidas
- Electrodomésticos
- Eletrónico
- Automobilístico e duas rodas
- Aplicações médicas e de laboratório
- Semi-condutores



### Temperatura d'uso

Temperature Range

Temperaturbereich

Température d'utilisation

Temperatura de Ejercicio

Temperatura de Trabalho

- 60 °C  
 + 260 °C



Tabella delle pressioni espresse in % in funzione della temperatura  
 Table of pressure values expressed in % as a function of temperature  
 Tabelle In Abhängigkeit Der Temperaturen Die Druckwerte In % Angegeben  
 Valeurs de pression (en %) en fonction de la température  
 Tabla de las presiones expresadas en % en función de la temperatura  
 Tabela das pressões expressas em % em função da temperatura

20°	50°	100°	150°	200°	250°
100%	85%	65%	50%	35%	25%

**TUBO IN POLIETILENE**

POLYETHYLENE TUBE  
 ROHRE AUS POLYETHYLEN  
 TUBE EN POLYÉTHYLÈNE  
 TUBO EN POLIETILENO  
 TUBO DE POLIETILENO

**TBPE**

**TUBO POLIETILENE (PELLD)**  
 POLYETHYLENE (PELLD) TUBE  
 ROHRE POLYETHYLEN (PELLD)  
 TUBE EN POLYÉTHYLÈNE (PELLD)  
 TUBO EN POLIETILENO (PELLD)  
 TUBO DE POLIETILENO (PELLD)

**New**

**Anti UV**

Code	Colore Color Farbe Couleur Color Cor				Est. mm	Int. mm	Raggio di curvatura Bending radius Biegeradius Rayon de courbure Radio curvatura Raio de curvatura mm	Pressione d'esercizio Working pressure Betriebsdruck Pression de travail Presión de ejercicio Pressão de trabalho a/at 20°C bar	Tolleranza Tolerance Toleranz Tolérance Tolerancia Tolerância mm	Pack. Mt
	White	Black	Red	Blue						
<b>TBPE 00 425</b>	<b>NT</b>	<b>NE</b>	<b>RO</b>	<b>AZ</b>	4	2.5	20	20	± 0.10	100
<b>TBPE 00 640</b>	<b>NT</b>	<b>NE</b>	<b>RO</b>	<b>AZ</b>	6	4	30	18	± 0.10	100
<b>TBPE 00 860</b>	<b>NT</b>	<b>NE</b>	<b>RO</b>	<b>AZ</b>	8	6	60	12	± 0.10	100
<b>TBPE 01 080</b>	<b>NT</b>	<b>NE</b>	<b>RO</b>	<b>AZ</b>	10	8	90	10	± 0.10	100
<b>TBPE 01 290</b>	<b>NT</b>	<b>NE</b>	<b>RO</b>	<b>AZ</b>	12	9	85	12	± 0.10	100

**Temperatura d'uso**

Temperature Range

Temperaturbereich



Température d'utilisation

Temperatura de Ejercicio

Temperatura de Trabalho

 - 20 °C  
 + 70 °C

Tabella delle pressioni espresse in % in funzione della temperatura  
 Table of pressure values expressed in % as a function of temperature  
 Tabelle In Abhängigkeit Der Temperaturen Die Druckwerte In % Angegeben  
 Valeurs de pression (en %) en fonction de la température  
 Tabla de las presiones expresadas en % en función de la temperatura  
 Tabela das pressões expressas em % em função da temperatura

20°	40°	50°	60°	70°
100%	70%	65%	55%	45%

## SPIRALI IN POLIAMIDE SENZA CODOLI

POLYAMIDE RECOIL TUBING WITHOUT TAIL  
 SPIRALROHRE AUS POLYAMID OHNE GERADE ENDEN  
 TUBE SPIRALÉ EN POLYAMIDE SANS EXTRÉMITÉS DROITES  
 ESPIRALES EN POLIAMIDA SIN TERMINALES  
 ESPIRAIS DE POLIAMIDA SEM ABAS

### SS12

#### SPIRALE IN POLIAMIDE SENZA CODOLI

POLYAMIDE RECOIL TUBING WITHOUT TAIL  
 SPIRALROHRE AUS POLYAMID OHNE GERADE ENDEN  
 TUBE SPIRALÉ EN POLYAMIDE SANS EXTRÉMITÉS DROITES  
 ESPIRAL EN POLIAMIDA SIN TERMINALES  
 ESPIRAL DE POLIAMIDA SEM ABAS



Code	Colore Color Farbe Couleur Color Cor	Est. mm	Int. mm	Ø Est. mm	Lunghezza Lineare Linear Length Gerade Länge Longueur Étirée Longitud Lineal Comprimento Linear Mt	Pressione d'esercizio	Pressione di scoppio	Tolleranza Tolerance Toleranz Tolérance Tolerancia Tolerância	Pack.
						a/at 20°C bar	a/at 20°C bar		
SS12 0064 030	BL	6	4	63	30	27	81	± 0.10	1
SS12 0086 030	BL	8	6	87	30	20	60	± 0.10	1
SS12 0108 030	BL	10	8	106	30	15	45	± 0.12	1
SS12 0121 030	BL	12	10	135	30	13	39	± 0.15	1



#### Temperatura d'uso

Temperature Range

Temperaturbereich

Température d'utilisation

Temperatura de Ejercicio

Temperatura de Trabalho

- 40 °C

+ 70 °C



Tabella delle pressioni espresse in % in funzione della temperatura  
 Table of pressure values expressed in % as a function of temperature  
 Tabelle In Abhängigkeit Der Temperaturen Die Druckwerte In % Angegeben  
 Valeurs de pression (en %) en fonction de la température  
 Tabla de las presiones expresadas en % en función de la temperatura  
 Tabela das pressões expressas em % em função da temperatura

-20°	0°	20°	30°	40°	50°	60°	70°
180%	140%	100%	90%	80%	70%	60%	50%

**SPIRALI IN POLIURETANO POLIETERE 95 SHORE A CON CODOLI**

POLYURETHANE POLYETHER 95 SHORE RECOIL TUBING WITH TAILS  
 SPIRALROHRE AUS POLYURETHAN-POLYETHER 95 SHORE A MIT GERADEN ENDEN  
 TUBE SPIRALÉ EN POLYURÉTHANE POLYÉTHÉR 95 SHORE A  
 ESPIRALES EN POLIURETANO POLIÉTER 95 SHORE A CON TERMINALES  
 ESPIRAIS DE POLIURETANO POLIÉTER 95 SHORE A COM ABAS

**SDPU**

**SPIRALE IN POLIURETANO POLIETERE 95 SHORE A CON CODOLI**

POLYURETHANE POLYETHER 95 SHORE RECOIL TUBING WITH TAILS  
 SPIRALROHRE AUS POLYURETHAN-POLYETHER 95 SHORE A MIT GERADEN ENDEN  
 TUBE SPIRALÉ EN POLYURÉTHANE POLYÉTHÉR 95 SHORE A AVEC EXTRÉMITÉS DROITES  
 ESPIRAL EN POLIURETANO POLIÉTER 95 SHORE A CON TERMINALES  
 ESPIRAL DE POLIURETANO POLIÉTER 95 SHORE A COM ABAS



Misura Size Größe Dimensions Tamaño	<b>1</b>	<b>2</b>
	mm	
<b>6 - 4</b>	100	100
<b>8 - 5.5</b>	120	500
<b>10 - 6.5</b>	120	500
<b>12 - 8</b>	120	500

Code	Colore Color Farbe Couleur Color Cor	Est.	Int.	Ø Est.	Lunghezza Lineare Linear lenght Gerade Länge Longueur étirée Longitud lineal Comprimento linear	Lunghezza a riposo	Lunghezza di Esercizio	Pressione d'esercizio	Pressione di scoppio	Tolleranza Tolerance Toleranz Tolerancia Tolerância	Pack.
						a/at 23°C	a/at 23°C	a/at 20°C	a/at 20°C		
		mm	mm	mm	Mt	mm	Mt	bar	bar	mm	
<b>SDPU 0064 004</b>	<b>AZ</b>	6	4	32	4	325	3	11	32	± 0.10	1
<b>SDPU 0085 505</b>	<b>AZ</b>	8	5.5	41	5	410	4	10	30	± 0.10	1
<b>SDPU 0106 505</b>	<b>AZ</b>	10	6.5	60	5	330	4	11	33	± 0.12	1
<b>SDPU 0120 805</b>	<b>AZ</b>	12	8	80	5	305	3	11	32	± 0.15	1
<b>SDPU 0085 075</b>	<b>AZ</b>	8	5.5	41	7.5	660	6	10	30	± 0.10	1
<b>SDPU 0106 575</b>	<b>AZ</b>	10	6.5	60	7.5	500	6	11	33	± 0.12	1
<b>SDPU 0120 875</b>	<b>AZ</b>	12	8	80	7.5	430	6	11	32	± 0.15	1



**Temperatura d'uso**

Temperature Range

Temperaturbereich

Température d'utilisation

Temperatura de Ejercicio

Temperatura de Trabalho

- 40 °C  
+ 60 °C



Tabella delle pressioni espresse in % in funzione della temperatura  
 Table of pressure values expressed in% as a function of temperature  
 Tabelle In Abhängigkeit Der Temperaturen Die Druckwerte In % Angegeben  
 Valeurs de pression (en %) en fonction de la température  
 Tabla de las presiones expresadas en % en función de la temperatura  
 Tabela das pressões expressas em % em função da temperatura

-20°	0°	20°	30°	40°	50°	60°
110%	100%	100%	85%	70%	60%	50%

**KIT SOFFIAGGIO**

BLOWER KIT  
 GEBLÄSE-KIT  
 KIT SOUFFLETTE  
 KIT DE VENTILADOR  
 KIT VENTILADOR



**Temperatura d'uso**

Temperature Range

Temperaturbereich

Température d'utilisation

Temperatura de Ejercicio

Temperatura de Trabalho

- 40 °C  
 + 60 °C



Tabella delle pressioni espresse in % in funzione della temperatura  
 Table of pressure values expressed in % as a function of temperature  
 Tabelle in Abhängigkeit Der Temperaturen Die Druckwerte In % Angegeben  
 Valeurs de pression (en %) en fonction de la température  
 Tabla de las presiones expresadas en % en función de la temperatura  
 Tabela das pressões expressas em % em função da temperatura

-20°	0°	20°	30°	40°	50°	60°
110%	100%	100%	85%	70%	60%	50%

**SK001**

**SPIRALE IN POLIURETANO POLIETERE 95 SHORE A CON RACCORDO DIRITTO ORIENTABILE MASCHIO CILINDRICO**

POLYURETHANE POLYETHER 95 SHORE A RECOIL TUBING WITH BSPP SWIVEL STRAIGHT MALE ADAPTOR

SPIRALROHRE AUS POLYURETHAN-POLYETHER 95 SHORE A MIT GERADE EINSCHRAUBVERSCHRAUBUNG ZYLINDRISCH (DREHBAR)

TUBE SPIRALÉ EN POLYURÉTHANE POLYÉTHÉTER 95 SHORE A AVEC RACCORD ORIENTABLE DROIT MÂLE CYLINDRIQUE

ESPIRAL EN POLIURETANO POLIÉTER 95 SHORE A CON RACOR RECTO ORIENTABLE MACHO CILÍNDRICO CON TÓRICA

ESPIRAL DE POLIURETANO POLIÉTER 95 SHORE A COM CONEXÃO RETA MACHO ORIENTÁVEL COM ROSCA PARALELA



Code	Colore Color Farbe Couleur Color Cor	Ø Int.	Ø Est.	Lunghezza Lineare Linear length Gerade Länge Longueur étirée Longitud lineal Comprimento linear	Filettatura Threads Gewindearten Filetages Roscas Roscas	Pack.
		mm	mm	Mt		
SK001 0640 02	AZ	4	6	2	1/4	1
SK001 0855 05	AZ	5.5	8	5	1/4	1
SK001 0855 75	AZ	5.5	8	7.5	1/4	1
SK001 1065 75	AZ	6.5	10	7.5	1/4	1
SK002 1208 75	AZ	8	12	7.5	3/8	1

## SK010

### SPIRALE IN POLIURETANO POLIETERE 95 SHORE A CON PISTOLE DI SOFFIAGGIO

POLYURETHANE POLYETHER 95 SHORE A RECOIL TUBING WITH BLOW GUN  
 SPIRALROHRE AUS POLYURETHAN-POLYETHER 95 SHORE A MIT BLASPISTOLEN  
 TUBE SPIRALÉ EN POLYURÉTHANE POLYÉTHÉR 95 SHORE A AVEC SOUFFLETTES  
 ESPIRAL EN POLIURETANO POLIÉTER 95 SHORE A CON PISTOLAS SOPLADORAS  
 ESPIRAL DE POLIURETANO POLIÉTER 95 SHORE A COM PISTOLA DE AR

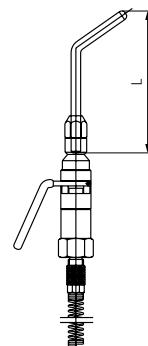

Code	Colore Color Farbe Couleur Color Cor	Ø Int. mm	Ø Est. mm	L mm	Lunghezza Lineare Linear lenght Gerade Länge Longueur étirée Longitud lineal Comprimento linear	Filettatura Threads Gewindearten Filetages Roscas Roscas	Pack.
					Mt	1/4	
SK010 0855 05	AZ	5.5	8	90	5	1/4	1

## SK022

### SPIRALE IN POLIURETANO POLIETERE 95 SHORE A CON PISTOLE DI SOFFIAGGIO 362

POLYURETHANE POLYETHER 95 SHORE A RECOIL TUBING WITH 362 BLOW GUN  
 SPIRALROHRE AUS POLYURETHAN-POLYETHER 95 SHORE A MIT BLASPISTOLEN 362  
 TUBE SPIRALÉ EN POLYURÉTHANE POLYÉTHÉR 95 SHORE A AVEC SOUFFLETTES 362  
 ESPIRAL EN POLIURETANO POLIÉTER 95 SHORE A CON PISTOLAS SOPLADORAS 362  
 ESPIRAL DE POLIURETANO POLIÉTER 95 SHORE A COM PISTOLA DE AR 362

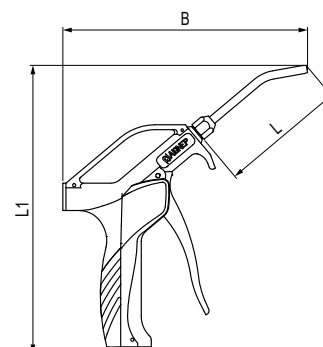

Code	Colore Color Farbe Couleur Color Cor	Ø Int. mm	Ø Est. mm	L mm	L1 mm	B mm	Lunghezza Lineare Linear lenght Gerade Länge Longueur étirée Longitud lineal Comprimento linear	Filettatura Threads Gewindearten Filetages Roscas Roscas	Pack.
							Mt	1/4	
SK022 0855 05	NE	5.5	8	90	210.5	179	5	1/4	1

## TUBO PVC MULTISTRATO EXTRAFLESSIBILE

PVC MULTILAYER SUPERFLEXIBLE HOSE  
MEHRSCICHTIGES PVC-ROHR SUPERFLEXIBEL  
TUBE MULTICOUCHE SUPERFLEXIBLE PVC  
TUBO MULTICAPA SUPERFLEXIBLE PVC  
TUBO MULTICAMADA SUPERFLEXIVEIS PVC

### TBPVM

#### TUBO PVC MULTISTRATO EXTRAFLESSIBILE - LUNGHEZZA 25 Mt

PVC MULTILAYER SUPERFLEXIBLE HOSE - LENGTH 25 Mt

MEHRSCICHTIGES PVC-ROHR SUPERFLEXIBEL - LÄNGE 25 Mt

TUBE MULTICOUCHE SUPERFLEXIBLE PVC - ROULEAU DE 25 Mt

TUBO MULTICAPA SUPERFLEXIBLE PVC - LONGITUD 25 Mt

TUBO MULTICAMADA SUPERFLEXIVEIS PVC - LUNGHEZZA 25 Mt



#### Temperatura d'uso

Temperature Range

Temperaturbereich

Température d'utilisation

Temperatura de Ejercicio

Temperatura de Trabalho

- 20 °C

+ 60 °C

Code	Colore Color Farbe Couleur Color Cor	Est. mm	Int. mm	Raggio di curvatura Bending radius Biegeradius Rayon de courbure Radio curvatura Raio de curvatura	Pressione d'esercizio Working pressure Betriebsdruck Pression de travail Presión de ejercicio Pressão de trabalho a/at 20°C	Pressione di scoppio Burst pressure Berstdruck Pression d'éclatement Presión de rotura Pressão de ruptura	Pack.
TBPVM 011 06	AZ	11	6,3	45	15	60	1
TBPVM 013 08	AZ	13	8	56	15	60	1
TBPVM 145 09	AZ	14.5	9	63	15	60	1
TBPVM 155 10	AZ	15.5	10	70	15	60	1
TBPVM 191 27	AZ	19	12,7	89	15	60	1
TBPVM 023 16	AZ	23	16	112	15	60	1

#### Applicazioni Industriali

- Industria in generale
- Industria automobilistica
- Industrie delle materie plastiche

#### Fluido compatibile

- Aria compressa

#### Resistenza chimica

- Chiedere all'ufficio tecnico

#### Industrial Applications

- Industry in general
- Automotive industry
- Plastics industry

#### Fluids

- Compressed air

#### Chemical resistance

- Request from the technical office

#### Industrielle Anwendungen

- Industrie im allgemeinen
- Automobilindustrie
- Kunststoffindustrie

#### Geeignete Medien

- Druckluft

#### Chemische Beständigkeit

- Anfrage beim Technischen Büro

#### Applications industrielles

- Industries général
- Industries automobile
- Industries plastiques

#### Fluides compatibles

- Air comprimé

#### Résistance chimique

- Demande du bureau technique

#### Aplicaciones industriales

- Industria en general
- Industria automotriz
- Industrias de plásticos

#### Fluidos compatibles

- Aire comprimido

#### Resistencia química

- Pregunte a la oficina técnica

#### Aplicações industriais

- Indústria em geral
- Indústria automotiva
- Indústrias de plásticos

#### Fluidos compatíveis

- Ar comprimido

#### Resistência química

- Pergunte ao escritório técnico

### 1770

#### FASCETTA STRINGITUBO PER TUBI PVC

CLAMPS FOR PVC HOSES

KLEMMEN FÜR PVC-ROHRE

COLLIERS DE SERRAGE POUR TUBES PVC

ABRAZADERAS PARA TUBO PVC

ABRAÇADEIRA POR TUBO PVC

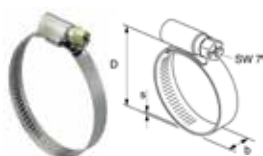

Code	D	B	S	Pack.
01770 00 001	8 - 12	9 mm	0.6 mm	50
01770 00 002	10 - 16	9 mm	0.6 mm	50
01770 00 003	12 - 20	9 mm	0.6 mm	50
01770 00 004	16 - 27	9 mm	0.6 mm	50



**TUBO IN POLIURETANO MULTISTRATO**

MULTILAYER POLYURETHANE TUBE  
 ROHRE MEHRSCICHTIGER AUS POLYURETHAN  
 TUBE MULTICOUCHE EN POLYURÉTHANE  
 TUBO EN POLIURETANO MULTICAPA  
 TUBO DE POLIURETANO MULTICAMADAS

**TBPUM**

**TUBO IN POLIURETANO MULTISTRATO - LUNGHEZZA 100 Mt**

MULTILAYER POLYURETHANE TUBE - LENGHT 100 Mt  
 ROHRE MEHRSCICHTIGER AUS POLYURETHAN - LÄNGE 100 Mt  
 TUBE MULTICOUCHE EN POLYURÉTHANE - ROULEAU DE 100 Mt  
 TUBO EN POLIURETANO MULTICAPA- LONGITUD 100 Mt  
 TUBO DE POLIURETANO MULTICAMADAS- LUNGHEZZA 100 Mt



**New**

Temperatura d'uso

Temperature Range

Temperaturbereich

Température d'utilisation

Temperatura de Ejercicio

Temperatura de Trabalho

- 30 °C  
 + 75 °C

Code	Colore Color Farbe Couleur Color Cor	Est.	Int.	Raggio di curvatura Bending radius Biegeradius Rayon de courbure Radio curvatura Raio de curvatura	Pressione d'esercizio Working pressure Betriebsdruck Pression de travail Presión de ejercicio Pressão de trabalho	Pressione di scoppio Burst pressure Berstdruck Pression d'éclatement Presión de rotura Pressão de ruptura	Pack.
		mm	mm	mm	a/at 23°C bar	a/at 23°C bar	
TBPUM 010 06	AZ	10	6	30	20	60	1
TBPUM 012 08	AZ	12	8	40	20	60	1
TBPUM 014 10	AZ	14.5	10	45	20	60	1

**Applicazioni Industriali**

**IT**

- Industria in generale
- Industria automobilistica
- Industrie delle materie plastiche

**Materiale**

- Tubo al 100% in poliuretano con rinforzo in poliestere

**Fluido compatibile**

- Aria compressa

**Resistenza chimica**

- Elevata resistenza alle aggressioni chimiche

**Industrial Applications**

**GB**

- Industry in general
- Automotive industry
- Plastics industry

**Material**

- 100% polyurethane hose with polyester reinforcement

**Fluids**

- Compressed air

**Chemical resistance**

- High resistance to chemical aggression

**Industrielle Anwendungen**

**DE**

- Industrie im allgemeinen
- Automobilindustrie
- Kunststoffindustrie

**Material**

- Schlauch aus 100% Polyurethan mit Polyesterverstärkung

**Geeignete Medien**

- Druckluft

**Chemische Beständigkeit**

- Hohe Widerstandsfähigkeit gegen chemische Angriffe

**Applications industrielles**

**FR**

- Industries général
- Industries automobile
- Industries plastiques

**Matériau**

- Tuyau 100% polyuréthane avec renfort en polyester

**Fluides compatibles**

- Air comprimé

**Résistance chimique**

- Haute résistance aux agressions chimiques

**Aplicaciones industriales**

**ES**

- Industria en general
- Industria automotriz
- Industrias de plásticos

**Material**

- Manguera 100% poliuretano con refuerzo de poliéster

**Fluidos compatibles**

- Aire comprimido

**Resistencia química**

- Gran resistencia a las agresiones químicas

**Aplicações industriais**

**PT**

- Indústria em geral
- Indústria automotiva
- Indústrias de plásticos

**Material**

- Mangueira 100% poliuretano com reforço de poliéster

**Fluidos compatíveis**

- Ar comprimido

**Resistência química**

- Alta resistência à agressão química

**TUBO PVC FOOD GRADE**

PVC TUBE FOOD GRADE  
 PVC ROHR LEBENSMITTELKONFORM  
 TUYAU PVC QUALITE ALIMENTAIRE  
 TUBO PVC FOOD GRADE  
 TUBO EM PVC ALIMENTÍCIO (FOOD GRADE)

**TBPV**

**TUBO PVC FOOD GRADE**  
 PVC TUBE FOOD GRADE  
 PVC SCHLAUCH FOOD GRADE  
 TUBES PVC FOOD GRADE  
 TUBO PVC FOOD GRADE  
 TUBO PVC FOOD GRADE



**Temperatura d'uso**

Temperature Range

Temperaturbereich

Température d'utilisation

Temperatura de Ejercicio

Temperatura de Trabalho

- 15 °C  
 + 60 °C

Code	Colore Color Farbe Couleur Color Cor	Est. mm	Int. mm	Pressione d'esercizio Working pressure Betriebsdruck Pression de travail Presión de ejercicio Pressão de trabalho		Raggio di curvatura Bending radius Biegeradius Rayon de courbure Radio curvatura Raio de curvatura		Pressione di scoppio Burst pressure Berstdruck Pression d'éclatement Presión de rotura Pressão de ruptura		Pack. Mt
				a/at 20°C bar	a/at 20°C bar	a/at 20°C mm	a/at 20°C mm	a/at 20°C bar	a/at 20°C bar	
<b>TBPV 01 370</b>	<b>NT</b>	13	7	21	21	46	46	63	63	25
<b>TBPV 16 100</b>	<b>NT</b>	16	10	20	20	74	74	60	60	100
<b>TBPV 23 150</b>	<b>NT</b>	23	15	20	20	120	120	60	60	50
<b>TBPV 26 190</b>	<b>NT</b>	26	19	13	13	174	174	40	40	50
<b>TBPV 33 250</b>	<b>NT</b>	33	25	13	13	260	260	40	40	50

**Applicazioni Industriali** **IT**

- Soluzioni Chimiche
- Per Industria alimentare
- Aria Compressa

**Materiale**

- PVC flessibile con rinforzo interno in fibra poliestere

**Fluido compatibile**

- Aria compressa, Alimenti associati ai simulanti A, B, C, D1 (es. sciroppi di zucchero, succhi di frutta, vino, latte)

**Resistenza chimica**

- Chiedere all'ufficio tecnico

**Industrial Applications** **GB**

- Chemical Solutions
- Food Industry
- Compressed Air

**Materials**

- Flexible PVC with polyester reinforcement

**Fluids**

- Compressed air, Foods associated with simulants A, B, C, D1 (e.g. sugar syrups, fruit juices, wine, milk)

**Chemical resistance**

- Request from the technical office

**Industrielle Anwendungen** **DE**

- Chemische Lösungen
- Lebensmittelindustrie
- Druckluft

**Materialien**

- Flexibler PVC mit Polyesterverstärkung

**Geeignete Medien**

- Druckluft, Lebensmittel mit Simulanzien A, B, C, D1 (z. B. Zuckersirupe, Fruchtsäfte, Wein, Milch)

**Chemische Beständigkeit**

- Anfrage beim Technischen Büro

**Applications industrielles** **FR**

- Solutions chimiques
- Industrie alimentaire
- Air comprimé

**Matériaux**

- PVC flexible avec renfort en polyester

**Fluides compatibles**

- Air comprimé, Aliments associés aux simulants A, B, C, D1 (par ex. sirops de sucre, jus de fruits, vin, lait)

**Résistance chimique**

- Demande du bureau technique

**Aplicaciones industriales** **ES**

- Soluciones químicas
- Industria de Alimentos
- Aire Comprimido

**Materiales**

- PVC flexible con refuerzo de hilo de poliéster

**Fluidos compatibles**

- Aire comprimido, Alimentos asociados con simulantes A, B, C, D1 (p. ej. jarabes de azúcar, zumos de frutas, vino, leche)

**Resistencia química**

- Pregunte a la oficina técnica

**Aplicações industriais** **PT**

- Soluções químicas
- Indústria Alimentícia
- Ar Comprimido

**Materiais**

- PVC flexível com reforço de fios de poliéster

**Fluidos compatíveis**

- Ar comprimido, Alimentos associados aos simuladores A, B, C, D1 (p. ex., xaropes de açúcar, sumos de fruta, vinho, leite)

**Resistência química**

- Pergunte ao escritório técnico

**TUBO AUTOBLOCCANTE**

PUSH-LOCK HOSE  
SCHNELLSTECKSCHLÄUCHE  
TUYAU AUTO-SERRANT  
TUBO AUTOBLOCCANTE  
TUBO PUSH-LOCK



**CARATTERISTICHE TECNICHE**

TECHNICAL CHARACTERISTICS  
TECHNISCHE ANGABEN  
CARACTÉRISTIQUES TECHNIQUES  
CARACTERÍSTICAS TÉCNICAS  
CARACTERÍSTICAS TÉCNICAS

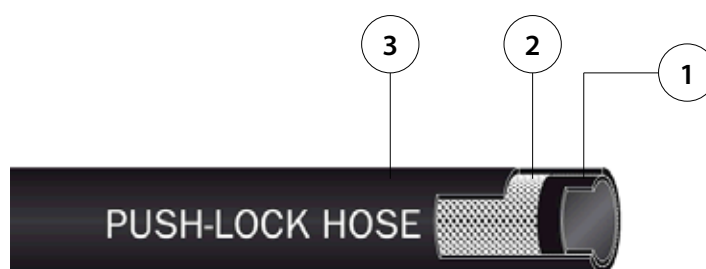

Materiali	IT	Materials	GB	Materialien	DE
1 Sottostrato: NBR/PVC liscio resistente agli oli.		1 Sublayer: NBR/PVC smooth, oil resistant.		1 Innenrohr: NBR/PVC glatt, Öl.	
2 Armatura: Tela Tessile.		2 Armor: Cloth Textiles.		2 Gewebeeinlage: Synthetische Textilfasern.	
3 Rivestimento: NBR/PVC liscio resistente alle abrasioni, agli oli e agli agenti atmosferici.		3 Finish: NBR/PVC smooth, abrasion, oil and weather resistant.		3 Aussenschicht: NBR/PVC glatt, Abriebfest, Öl- und Witterungsbeständig.	
Materiaux	FR	Materiales	ES	Materiais	PT
1 Tube: NBR/PVC lisse, résistant aux huiles.		1 Tubo interior: NBR/PVC liso resistente a los aceites.		1 Tubo interior: NBR/PVC suave resistente a óleos.	
2 Armature: Fibres textiles.		2 Armadura: Trenza Textil		2 Armadura: Trançado Têxtil	
3 Revêtement extérieur: NBR/PVC lisse, résistant à l'abrasion, aux huiles et aux intempéries.		3 Tubo exterior: NBR/PVC liso resistente a la abrasión, a los aceites y a los agentes atmosféricos.		3 Tubo exterior: NBR/PVC suave resistência a abrasão, a óleos, a agentes atmosférico.	

**COLORI STANDARD**  
STANDARD COLORS  
STANDARD FARBEN  
COULEURS STANDARDS  
CORES PADRÃO

	<b>RO</b>	ROSSO RED ROT ROUGE ROJO VERMELHO
	<b>BL</b>	AZZURRO LIGHT BLUE HELLBLAU BLEU CLAIR AZUL AZUL CLARO
	<b>VE</b>	VERDE GREEN GRÜN VERT VERDE VERDE
	<b>NE</b>	NERO BLACK SCHWARZ NOIR NEGRO PRETO



Temperatura con aria compressa Temperature with compressed air Mit Druckluft Avec de l'air comprimé Con aire comprimido Com ar comprimido	<b>-20°C</b>	<b>+110°C</b> con picchi di 125°C peak +125°C Kurzfristig +125°C Pic à +125°C con picos de +125 °C com picos de + 125 °C
Temperatura con acqua Temperature with water Mit Wasser Avec de l'eau Con Agua Com Água	<b>0°C</b>	<b>+100°C</b> con picchi di 110°C peak +110°C Kurzfristig +110°C Pic à +110°C con picos de +110 °C com picos de + 110 °C
Temperatura con olio idraulico Temperature with hydraulic oil Mit Hydrauliköl Avec de l'huile hydraulique Con aceites hidráulicos Com óleos hidráulicos	<b>-20°C</b>	<b>+70°C</b> con picchi di 90°C peak +90°C Kurzfristig +90°C Pic à +90°C con picos de +90 °C com picos de + 90 °C
Temperatura con Acqua Glicole Temperature with Water Glycol Mit Glykolwasser Avec de l'eau glycolé Con Agua Glicol Com Água e Glicol	<b>-20°C</b>	<b>+70°C</b> con picchi di 90°C peak +90°C Kurzfristig +90°C Pic à +90°C con picos de +90 °C com picos de + 90 °C



### Pressioni

Pressures

Druckbereich

Pressions

Presiones

Pressões

**16 bar** (1.6 MPa)



### Fluidi compatibili

Aria compressa / Acqua / Olio Idraulico / Acqua Glicole / Gasolio / Benzina

### Fluids

Compressed air / Water / Hydraulic Oil / Water Glycol / Diesel Fuel / Petrol

### Geeignete Medien

Druckluft / Wasser / Hydrauliköl / Glykolwasser / Dieselkraftstoff / Benzin

### Fluides compatibles

Air comprimé / Eau / Huile Hydraulique / Eau glycolé / Carburant diesel / Essence

### Fluidos compatibles

Aire comprimido / Agua / Aceite hidráulico / Agua Glicol / Combustible Diesel / Gasolina

### Fluidos compatíveis

Ar comprimido / Água / Óleo hidráulico / Água e Glicol / Combustível Diesel / Gasolina

## TBPL

### TUBO AUTOBLOCCANTE

PUSH-LOCK HOSE

SCHNELLSTECKSCHLÄUCHE

TUYAUX AUTO-SERRANTS

TUBERÍA AUTOBLOCANTE

TUBO PUSH-LOCK



Code	Code	Code	Code	Int.	Int.	Est.	Raggio di curvatura Bending radius Biegeradius Rayon de courbure Radio curvatura Raio de curvatura	Pressione d'esercizio Working pressure Betriebsdruck Pression de travail Presión de ejercicio Pressão de trabalho	Pressione di scoppio Burst pressure Berstdruck Pression d'éclatement Presión de rotura Pressão de ruptura	Pack.
				inch	mm	mm	mm	bar	bar	Mt
TBPL 1/4 0 RO 100	TBPL 1/4 0 BL 100	TBPL 1/4 0 VE 100	TBPL 1/4 0 NE 100	1/4	6.3	12.4	45	16	64	100
TBPL 3/8 0 RO 100	TBPL 3/8 0 BL 100	TBPL 3/8 0 VE 100	TBPL 3/8 0 NE 100	3/8	9.6	15.5	75	16	64	100
TBPL 1/2 0 RO 100	TBPL 1/2 0 BL 100	TBPL 1/2 0 VE 100	TBPL 1/2 0 NE 100	1/2	12.7	18.7	90	16	64	100
TBPL 5/8 0 RO 080	TBPL 5/8 0 BL 080	TBPL 5/8 0 VE 080	TBPL 5/8 0 NE 080	5/8	16	22.9	115	16	64	80
TBPL 3/4 0 RO 080	TBPL 3/4 0 BL 080	TBPL 3/4 0 VE 080	TBPL 3/4 0 NE 080	3/4	19.2	26.5	135	16	64	80

Vedi raccordi da utilizzare Pag 16.32 / 16.33 / 16.34

See Push-lock fittings on Pag 16.32 / 16.33 / 16.34

Siehe dazu passende Verschraubungen im Pag 16.32 / 16.33 / 16.34

A utiliser avec les douilles annelées Pag 16.32 / 16.33 / 16.34

Ver racores a utilizar Pag 16.32 / 16.33 / 16.34

Veja conexões a serem utilizadas Pag 16.32 / 16.33 / 16.34

**ACCESSORI**

ACCESSORIES  
ZUBEHÖR  
ACCESSOIRES  
ACCESORIOS  
ACESSÓRIOS

**SEAL01**

**SIGILLAFILETTI**  
THREAD SEALANT  
SCHRAUBENSICHERUNG  
ÉTANCHÉITÉ FILETÉE  
SELLANTE DE ROSCAS  
VEDANTE DE ROSCAS



Code	Size	Pack.
<b>SEAL01</b>	75 ml - 82 g	10

Utilizzare con aria compressa, gas naturale, acqua potabile (trascorse 24h dall'applicazione) e gas.  
Use with compressed air, natural gas, drinking water (after 24 hours from application) and gases.  
Anwendung mit Druckluft, Erdgas, Trinkwasser (nach 24 Stunden nach der Anwendung) und Gase.  
Utiliser avec de l'air comprimé, gaz naturel, eau potable (24 heures après l'application) et gaz.  
Aplicación con aire comprimido, gas natural, agua potable (después 24 horas de la aplicación) y gases.  
Aplicação com ar comprimido, gás natural, água potável (após 24 horas da aplicação) e gases.

**NAFE**

**NASTRO IN PTFE**  
PTFE TAPE  
TEFLONBAND PTFE  
BANDE FLUOROPOLYMÈRE  
ROLLO PTFE  
FITA EM PTFE



Code	Size	Pack.
<b>NAFE01 20 10 12</b>	12 mm x 0.1 mm x 12 Mt	10

**1740**

**STAFFA FISSA TUBO**  
FIXED BRACKET TUBE  
CLIPLEISTE  
CLIP DE FIXATION  
BRIDAS PARA TUBO  
SUPORTE FIXA-TUBO



Code	Tube Position	Pack.
<b>01740 00 001</b>	<b>10 x 4 mm</b>	10
<b>01740 00 002</b>	<b>10 x 6 mm</b>	10
<b>01740 00 003</b>	<b>10 x 8 mm</b>	10
<b>01740 00 004</b>	<b>10 x 10 mm</b>	10
<b>01740 00 005</b>	<b>8 x 12 mm</b>	10
<b>01740 00 006</b>	<b>8 x 14 mm</b>	10

0 °C  
+ 40 °C

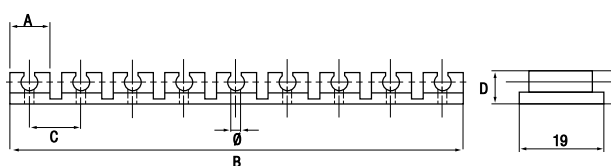

Ø Tube mm	A mm	B mm	C mm	D mm	Ø mm	N° posizioni N° positions Anzahl Positionen Nombre fixations N° de posições
4	9	114	11.7	8	2.8	10
6	9	114	11.7	10	2.8	10
8	12	143	14.6	12	3.8	10
10	15	172	17.4	13.8	5.3	10
12	19	76	20.5	16.8	5.3	8
14	21	87	22.5	18.8	5.3	8

**Vantaggi nelle applicazioni**

**IT**

- Installazione rapida
- Ingombri ridotti
- Inattaccabili da agenti atmosferici
- Ottima resistenza alle vibrazioni
- Fissaggio rapido del tubo con semplice pressione

**Advantages in applications**

**GB**

- Quick fitting
- Space Saving
- Weather ability
- Excellent resistance to vibrations
- Quick tube fitting by simple pressure

**Anwendungs Vorteile**

**DE**

- Schnelle Montage
- Platzsparend
- Wetterfest
- Sehr gute Vibrationsbeständigkeit
- Schneller Rohranschluss durch einfaches Drücken

**Avantages dans les applications**

**FR**

- Fixation rapide
- Encombrement réduit
- Bonne tenue
- Excellente résistance aux vibrations
- Accrochage rapide du tube par simple pression

**Ventajas en las aplicaciones**

**ES**

- Rápida instalación
- Reducidas dimensiones
- Resistente de agentes atmosféricos
- Óptima resistencia a la vibración
- Fijación rápida del tubo con una simple presión

**Vantagens em aplicações**

**PT**

- Conexão rápida
- Redução de espaço
- Resistência a intempéries e à agentes atmosféricos
- Excelente resistência a vibração
- Encaixe do tubo com força reduzida

## 1750

### TAGLIATUBO IN TECNOPOLIMERO

TECHNOPOLYMER PIPE CUTTER  
ROHRSCHEIDER KUNSTSTOFF  
COUPE TUBE POUR TUBE PLASTIQUE  
CORTATUBOS EN PLÁSTICO  
CORTADOR DE TUBOS EM PLÁSTICO



Code	Size	Pack.
01750 00 001	14 mm Max	10

## 1752

### TAGLIATUBO IN METALLO PER TUBI PLASTICI

METAL CUTTER FOR PLASTIC PIPE  
ROHRSCHEIDER  
PINCE COUPE-TUBES  
CORTATUBO METÁLICO  
ALICATE METÁLICO CORTA-TUBOS



Code	Tube	Pack.
01752 00 001	15.5 mm Max	1
01752 00 002	25 mm Max	1

## 1753

### LAMA DI RICAMBIO PER 1752

SPARE BLADE 1752  
ERSATZKLINGEN FÜR 1752  
LAMES DE RECHANGE POUR 1752  
CUCHILLA DE RECAMBIO PARA 1752  
LÂMINA DE REPOSIÇÃO PARA 1752



Code	Tube	Pack.
01753 00 001	15.5 mm Max	5
01753 00 002	25 mm Max	5

## 1755

### PINZA TAGLIA TUBO ANTISCINTILLA

ANTI-SPARK TUBE CUTTER  
SCHNEIDER FÜR SCHWEISSSPRITZABWEISENDES ROHR  
PINCE DE DEGAINAGE POUR TUBE ANTI ETINCELLE  
PINZA CORTA TUBO ANTICHISPA  
PINÇA CORTA-TUBOS PARA TUBO ANTI-CHAMA



Code	Tube	Pack.
01755 00 001	6 - 8 mm	1
01755 00 002	10 - 12 mm	1

**AVVOLGITUBO**

HOSE REEL  
SCHLAUCHAUFWOLLER  
ENROULEURS  
RECOGETUBOS  
MANGUEIRAS

**Code: 90825 00 001 9+1**

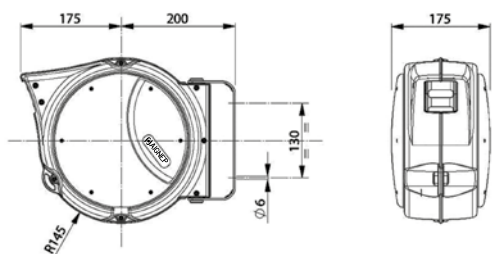

**Code: 90825 00 003 15+1**

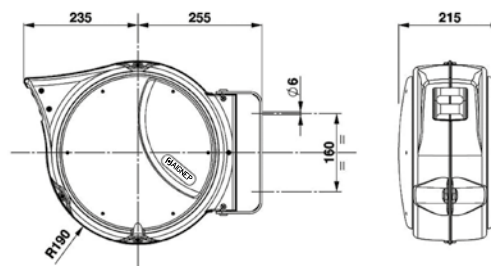

	90825 00 001 9+1	90825 00 003 15+1
<b>Tubo poliuretano</b> Polyurethane tube Rohr Polyurethan Tube polyuréthane Tubo poliuretano Tubo poliuretano	Ø INT. 8mm (5/16") Ø EXT. 12mm	Ø INT. 10mm Ø EXT. 14mm
<b>Lunghezza tubo (m)</b> Tube length (m) Rohr Länge (m) Longueur de tube (m) Longitud tubo (m) Comprimento de tubo (m)	9+1	15+1
<b>Pressione massima</b> Max pressure Max. Druck Pressions maximale Presión máxima Máx. Press.	15 bar (1.5 MPa)	
<b>Temperatura</b> Temperature Temperatur Température Temperatura Temperatura	- 5 °C + 40 °C	
<b>Raccordo in uscita</b> Outlet fitting Anschluss beim Ausgang Raccordement amont Conector de salida Conexão de saída	1/4 M	3/8 M

	90825 00 001 9+1	90825 00 003 15+1
<b>Raccordo in entrata</b> Inlet fitting Anschluss beim Eingang Raccordement aval Conector de entrada Conexão de entrada	NO	
<b>Spezzone ingresso</b> Cut down size tube Länge des Eingangsrohres Longueur du tube en amont Extremo del tubo Comprimento de entrada	1.5 m	
<b>Aria</b> Air Luft Air Aire Ar	SI	
<b>Conf. Pack.</b> Verp. Cond. Embalaje Embal.	390x330x230 mm Kg 4.5	500x450x255 mm Kg 8.0
<b>Portata a 6 bar</b> 6 bar flow rate Durchflusswert bei 6 bar Débit à 6 bar Caudal a 6 bar Vazão a 6 bar	450 NI/min	610 NI/min

**IT**

- Staffa di fissaggio metallica orientabile
- Dispositivo automatico di arresto del tubo alla lunghezza desiderata. Questo dispositivo è facilmente disinseribile, qualora si voglia il tubo costantemente in trazione.

**GB**

- Metal swivel fixing bracket
- Automatic device to stop tube at chosen length. This device is easy to disconnect whenever you may need tube in constant traction.

**DE**

- Drehbarer Metallbügel
- Mit einer Verriegelungsvorrichtung um das Rohr bei der gewünschten Länge zu stoppen. Dieses Gerät kann leicht demontiert werden, um einen gleichmäßigen Zug auf dem Rohr zu haben.

**FR**

- Embase métallique pivotante
- Equipé d'un dispositif de blocage du tuyau à la longueur souhaitée. Ce dispositif peut être facilement démonté afin d'obtenir une traction constante sur le tuyau.

**ES**

- Soporte de metal para fijar.
- Dispositivo automático para detener el tubo y elegir el largo

**PT**

- Suporte de fixação metálico orientável
- Dispositivo automático de parada de tubo na posição desejada. Este dispositivo é facilmente desconectado, quando se necessita do tubo em constante tração.

## BILANCIATORE CON TUBO SPIRALATO

BALANCER WITH COILED TUBING  
 FEDERZUG MIT SPIRALROHR  
 ENROULEUR ÉQUILIBREUR AVEC TUBE SPIRALÉ  
 BALANCEADOR CON TUBO EN ESPIRAL  
 ALACIM CON TUBO ESPIRALADO

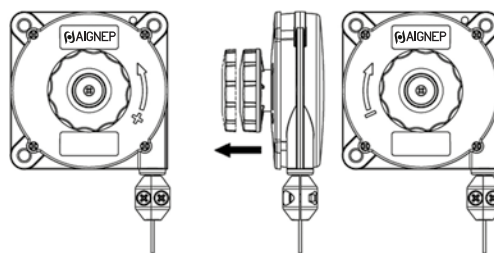
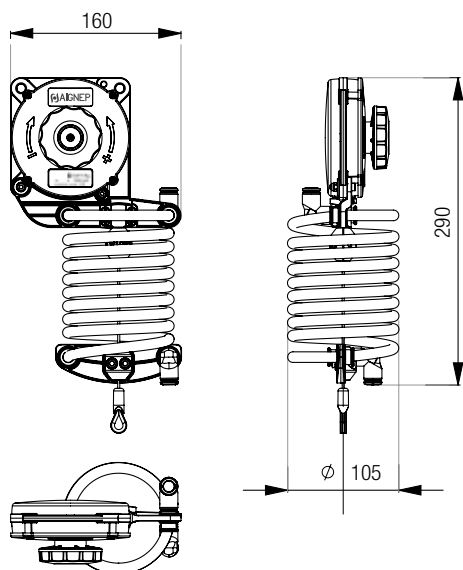
**Code: 90826**

Regolazione del carico  
 Adjusting the load  
 Einstellen der Last  
 Réglage de la charge  
 Ajuste de la carga  
 Ajuste da carga

	90826 00 0010	90826 00 002	90826 00 003
<b>Portata (Kg)</b> Capacity (Kg) Kapazität (Kg) Capacité (Kg) Caudal (Kg) Vazão (Kg)	0.4 ÷ 1	1 ÷ 2	2 ÷ 3
<b>Cavo in acciaio</b> Stainless steel rope Stahlseil Câble en acier Cable de acero inoxidable Cabo de aço inoxidável		Ø 2 mm	
<b>Corsa cavo</b> Stroke rope Hublänge Course Longitude cable Largura cabo		1600 mm	
<b>Tubo PA12</b> Tube Rohr Tube Tubo Tubo		Ø INT. 8 mm (5/16") Ø EXT. 10 mm	
<b>Pressione massima</b> Max pressure Druckbereich max Pressions maximale Presión máxima Máx. Press.		10 bar (1 MPa)	

	90826 00 0010	90826 00 002	90826 00 003
<b>Raccordo entrata-uscita</b> Inlet-outlet fitting Anschluss IN/OUT Connexion IN/OUT Conexiones entrada/salida Conexão de saída/entrada		<b>Raccordo automatico Ø 10</b> Push-in fitting Ø 10 Steckverschraubungen Ø10 Raccords instantanés Ø 10 Racordaje automático Ø 10 Conexões Push-in Ø 10	
<b>Spezzone ingresso</b> Cut down size tube Anpassung Adaptable Extremo del tubo Comprimento de entrada		1 m	
<b>Aria</b> Air Luft Air Aire Ar		SI	
<b>Conf.</b> Pack. Verp. Cond. Embalaje Embal.		1	