









Prese ad Innesto Rapido - Quick Couplings - Schnellverschluss Kupplungen - Coupleurs Automatiques - Enchufes Rápidos - Conexões de Engate Rápido

<p>SERIE UNI ISO 6150 A-6</p>  <p>Serie 100 Pag. 15.7 - 15.10</p>	<p>SERIE MIGNON New</p>  <p>Serie 110 Pag. 15.11 - 15.16</p>	<p>SERIE UNI ISO 6150 B-12</p>  <p>Serie 120 Pag. 15.17 - 15.22</p>	<p>ITALIAN PROFILE</p>  <p>Serie 120 Pag. 15.23 - 15.28</p>
<p>SERIE UNI ISO 6150 B-15</p>  <p>Serie 130 Pag. 15.29 - 15.33</p>	<p>SERIE UNI ISO 6150 C-10</p>  <p>Serie 140 Pag. 15.34 - 15.39</p>	<p>EUROPEAN PROFILE</p>  <p>Serie 160 Pag. 15.40 - 15.45</p>	<p>SWISS PROFILE</p>  <p>Serie 170 Pag. 15.46 - 15.50</p>
<p>MIGNON PROFILE New</p>  <p>Serie 180 Pag. 15.51 - 15.54</p>	<p>MULTISOCKET New</p>  <p>Serie 190 - 63190 Pag. 15.55 - 15.61</p>	<p>JAPANESE PROFILE</p>  <p>Serie 400 Pag. 15.62 - 15.64</p>	<p>Serie 700 Pag. 15.65 - 15.67</p>
<p>SERIE UNI ISO 6150 B-17</p>  <p>Serie 710 Pag. 15.68 - 15.70</p>	<p>B-SOCKET EUROPEAN</p>  <p>Serie 720 Pag. 15.71 - 15.74</p>	<p>EUROPEAN PROFILE New</p>  <p>Serie 730 Pag. 15.75 - 15.80</p>	<p>EUROPEAN PROFILE New</p>  <p>Serie 740 Pag. 15.81 - 15.83</p>

Prese di Sicurezza ad Innesto Rapido - Safety Quick Couplings - Kupplungen Sicherheit - Coupleurs de Sécurité - Enchufes de Seguridad - Conexões de Segurança

<p>SERIE UNI ISO 6150 B-12</p>  <p>Serie 620 Pag. 15.85 - 15.88</p>	<p>ITALIAN PROFILE</p>  <p>Serie 650 Pag. 15.89 - 15.90</p>	<p>EUROPEAN PROFILE</p>  <p>Serie 660 Pag. 15.91 - 15.92</p>	<p>SWISS PROFILE</p>  <p>Serie 670 Pag. 15.93 - 15.94</p>
<p>SERIE UNI ISO 6150 B-12</p>  <p>Serie 0B120 Pag. 15.97 - 15.99</p>	<p>SERIE UNI ISO 6150 C-10</p>  <p>Serie 0B140 Pag. 15.100 - 15.102</p>	<p>EUROPEAN PROFILE New</p>  <p>Serie 0B160 Pag. 15.103 - 15.105</p>	

Giunti ad Innesto Rapido per Raffreddamento Stampi - Quick Couplings for Molding Cooling - Schnellkupplungen für Spritzgussanwendungen - Coupleurs pour Moules D'injection - Enchufes Rápidos para Refrigeración de Moldes - Conexões de Engate Rápido para Resfriamento de Moldes

<p>FRENCH PROFILE DN 8 - DN 12</p>  <p>Series 410 - 420 - 510 - 520 Pag. 15.104 - 15.110</p>	<p>INTERNATIONAL PROFILE DN 6 - DN 9</p>  <p>Series 430 - 440 - 530 - 540 Pag. 15.112 - 15.119</p>	<p>EUROPEAN PROFILE DN 6 - DN 9</p>  <p>Series 460 - 470 - 560 - 570 Pag. 15.120 - 15.127</p>	<p>6049 Pag. 15.128</p> 
--	--	--	--

Pistole di Soffiaggio - Blow Guns - Blaspistolen - Soufflettes - Pistolas Sopladoras - Pistola de Ar

 <p>Series 360 Pag. 15.130 - 15.132</p>	 <p>Series 300 Pag. 15.133 - 15.135</p>	 <p>Spare Parts Pag. 15.136</p>	 <p>Series 340 Pag. 15.137</p>
---	---	--	--

Alignep si riserva il diritto di variare modelli e ingombri senza preavviso - Alignep reserves the right to vary models and dimensions without notice - Alignep behält sich das Recht vor, Daten ohne Ankündigung zu ändern
 Alignep se reserva el derecho de modificar modelos y dimensiones sin previo aviso - Alignep se reserva o direito de alterar os modelos e dimensões sem prévio aviso

SERIE OB140 UNI ISO 6150-C10



CARATTERISTICHE TECNICHE
 TECHNICAL CHARACTERISTICS
 TECHNISCHE ANGABEN
 CARACTÉRISTIQUES TECHNIQUES
 CARACTERÍSTICAS TÉCNICAS
 CARACTERÍSTICAS TÉCNICAS



Norma di Riferimento
 Reference standard
 Entspricht der Norm
 Norme de référence
 Normativa de referencia
 Norma de referència

1907/2006 REACH ✓	2011/65/CE RoHS ✓	ISO 4414
PED 2014/68/UE	SILICON FREE	

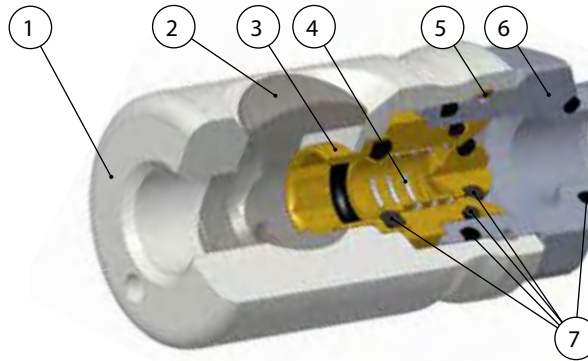

CONSIGLIATA CON INNESTI ACCIAIO
 ADVISE WITH STEEL PLUG
 EMPFOHLENE STECKER AUS STAHL
 EMBOUT RECOMMANDE EN ACIER
 ACONSEJADOS CON ADAPT EN ACERO
 ACONSELHADA COM PLUG EM AÇO



ORIENTABILE
 ORIENTING
 DREHBAR
 ORIENTABLE
 ORIENTABLE
 ORIENTÁVEL

DN
 5.5 mm

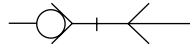

UNI ISO 6150-C10

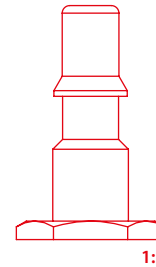

Materiali e Componenti	IT	Component Parts and Materials	GB	Komponenten und Materialien	DE
1 Corpo in alluminio		1 Aluminium Body		1 Körper Aluminium	
2 Pulsante in acciaio		2 Steel button		2 Stahl Knopf	
3 Otturatore in ottone		3 Brass Shutter		3 Verschluss Messing	
4 Anello in ottone		4 Brass ring		4 Führungsring Messing	
5 Molla contrasto otturatore in acciaio INOX AISI 302		5 INOX steel AISI 302 shutter thrust spring		5 Verschlussfeder Edelstahl AISI 302	
6 Attacco terminale in ottone nichelato		6 Nickel-plated brass coupling back part		6 Einschraubkörper Messing vernickelt	
7 Guarnizione O-Ring in NBR		7 NBR O-ring		7 O-Ring NBR	
Matériaux et Composants	FR	Materiales y Componentes	ES	Materiais e Componentes	PT
1 Corps: Aluminium		1 Cuerpo en Aluminio		1 Corpo em Alumínio	
2 Bouton en acier		2 Botón de acero		2 Botão de aço	
3 Iapet: Laiton		3 Obturador en latón		3 Obturador em latão	
4 Bague de guidage: laiton		4 Anillo en latón		4 Anel em Latão	
5 Ressort de bague: acier inoxydable AISI 302		5 Muelle empuje obturador en acero INOX AISI 302		5 Mola do obturador em aço INOX AISI 302	
6 Corps: laiton nickelé		6 Terminal en latón níquelado		6 Terminal en latón níquelado	
7 Joint torrique: NBR		7 Junta tórica en NBR		7 Vedação O-Ring em NBR	



Pressione d'esercizio

Working Pressures

Betriebsdruck

Pression de service

Presión de Ejercicio

Pressão de Trabalho

0 bar (0 MPa)

15 bar (1.5 MPa)



Temperature

Temperatures

Temperatur

Températures

Temperaturas

Temperaturas

- 20 °C

+ 80 °C



Fluidi compatibili

Aria compressa

Fluids

Compressed air

Geeignete Medien

Druckluft

Fluides compatibles

Air comprimé

Fluidos compatibles

Air comprimido

Fluidos compatíveis

Ar comprimido



Portata

NI/min

Flow Rate

Durchflusswerte

Débit

Caudal de Flujo

Vazão

6 bar Δ 1	6 bar Δ 0.5	6 bar *
900	650	1300

* Scarico libero - Exhaust Free - Kostenlose Auspuff - Échappement libre - Escape Libre - Descarga libre.



Filetatura

IT

Threads

GB

Gewindearten

DE

Gas cilindrica conforme ISO 228 Classe A.

Parallel gas in conformity with ISO 228 Class A.

Zylindrisches Gewinde nach Norm ISO 228 Classe A.

Filetages

FR

Roscas

ES

Roscas

PT

Filetage cylindrique conforme: ISO 228 Class A.

Gas cilindrica conforme ISO 228 Clase A.

Gas paralela conforme ISO 228 Classe A.

OB141

PRESA DI SICUREZZA MASCHIO CILINDRICO CON OR

SAFETY MALE CILINDRIC SOCKET WITH OR

VERSCHLUSS-KUPPLUNG SICHERHEIT MIT AUSSENGEWINDE ZYLINDRISCH MIT OR

COUPLEUR DE SÉCURITÉ MÂLE CYLINDRIQUE AVEC OR

ENCHUFE DE SEGURIDAD MACHO CILINDRICA CON OR

SOQUETE DE SEGURANÇA COM ROSCA MACHO PARALELA COM OR

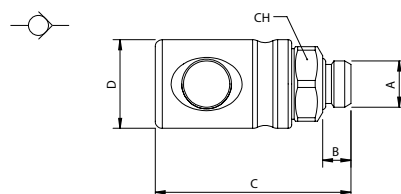

Code	A	B	C	D	CH	Pack.
OB141 00 001	1/4	8	55	25	21	10
OB141 00 002	3/8	9	56	25	21	10
OB141 00 003	1/2	10	59	25	25	10

OB142

PRESA DI SICUREZZA FEMMINA

SAFETY FEMALE CILINDRIC SOCKET

VERSCHLUSS-KUPPLUNG SICHERHEIT MIT INNENGEWINDE

COUPLEUR DE SÉCURITÉ FEMELLE

ENCHUFE DE SEGURIDAD HEMBRA

SOQUETE DE SEGURANÇA COM ROSCA FÊMEA

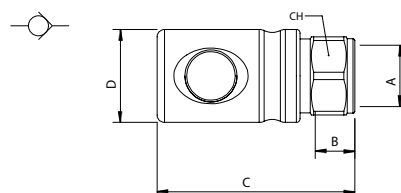

Code	A	B	C	D	CH	Pack.
OB142 00 001	1/4	9	53	25	21	10
OB142 00 002	3/8	12	56	25	21	10
OB142 00 003	1/2	15	60	25	24	10

OB145

PRESA DI SICUREZZA PORTAGOMMA

SAFETY SOCKET FOR RUBBER HOSE

STECKER SICHERHEIT FÜR GUMMISCHLAUCH

COUPLEUR DE SECURITE POUR TUYAU

ENCHUFE DE SEGURIDAD CON PORTAGOMA

PLUG DE SEGURANÇA COM ESMIGÃO PARA TUBO DE BORRACHA

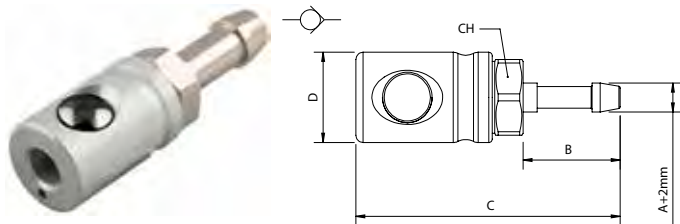

Code	A	B	C	D	CH	Pack.
OB145 00 001	6	27.5	75	25	21	10
OB145 00 002	8	27.5	75	25	21	10
OB145 00 003	10	27.5	75	25	21	10
OB145 00 004	12	33	80	25	21	10

241AC

INNESTO IN ACCIAIO MASCHIO

STEEL MALE PLUG

STECKER MIT AUSSENGEWINDE AUS STAHL

EMBOUT MÂLE EN ACIER

ADAPTADOR EN ACERO MACHO

PLUG EM AÇO COM ROSCA MACHO

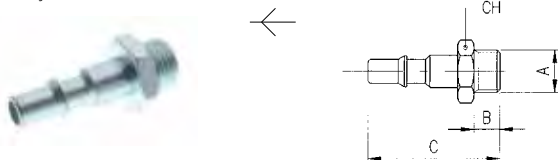

Code	A	B	C	CH	Pack.
241AC 00 51 03 ZI	1/4	8	41.5	17	10
241AC 00 51 04 ZI	3/8	9	42.5	19	10
241AC 00 51 05 ZI	1/2	10	44	24	10

Acciaio Indurito
Hardened Steel
Gehärtetem Stahl
Acier Trempé
Acero Curtido
Aço Endurecido

242AC

INNESTO IN ACCIAIO FEMMINA

STEEL FEMALE PLUG

STECKER MIT INNENGEWINDE AUS STAHL

EMBOUT FEMELLE EN ACIER

ADAPTADOR EN ACERO HEMBRA

PLUG EM AÇO COM ROSCA FÊMEA

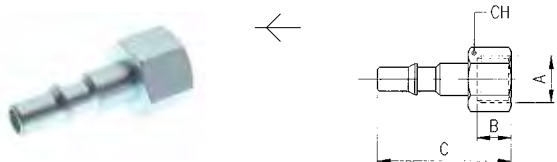

Code	A	B	C	CH	Pack.
242AC 00 51 03 ZI	1/4	11	41.5	17	10
242AC 00 51 04 ZI	3/8	11.5	42	19	10
242AC 00 51 05 ZI	1/2	14	44.5	24	10

Acciaio Indurito
Hardened Steel
Gehärtetem Stahl
Acier Trempé
Acero Curtido
Aço Endurecido

245AC

INNESTO IN ACCIAIO CON PORTAGOMMA A RESCA

STEEL BARBED PLUG

STECKER MIT SCHLAUCHTÜLLE AUS STAHL

EMBOUT À DOUILLE ANNELÉE POUR TUBE EN ACIER

ADAPTADOR EN ACERO EPIGA

PLUG EM AÇO COM ESMIGÃO PARA TUBO DE BORRACHA



Code	A	C	D	Pack.
245AC 00 51 X4 ZI	6	48	10	10
245AC 00 51 X7 ZI	8	51	12	10
245AC 00 51 X9 ZI	10	51	14	10
245AC 00 51 Y1 ZI	12	51	16	10

Acciaio Indurito
Hardened Steel
Gehärtetem Stahl
Acier Trempé
Acero Curtido
Aço Endurecido